



SK magic Dishwasher

Triple Care Series

DWA19R0P

DWA19C0P



- Please read the safety precautions in this manual thoroughly before use to ensure safe operation.
- Please store the manual in a safe location close to the appliance for future reference.
- The structure and exterior of the appliance may be enhanced for quality improvement without prior notice.

(REV.00)

Contents

Safety Information	3	Loading Dishes	24
Installation Guidelines	3	Separating the Upper/Lower Racks	24
Power Source Guidelines	4	Suggested Loading Pattern	25
Usage Guidelines	4	Rack Loading Tips	26
Product Breakdowns & Repairs	6	Maintenance	30
Before Using the Dishwasher	7	Cleaning the Filter	30
Before First Use	7	Cleaning the Dish Racks	31
Preparing for Wash	7	Cleaning the Inside and Outside of the Product	32
Product Description	8	Managing Issues	32
External Parts	8	Replacing the Water Care Filter (Applicable models only)	34
Parts	8	Replacing the Air Care Filter (Applicable models only)	35
Internal Parts	9	Troubleshooting	36
Separate Purchases	9	Information Codes	37
Display & Control Panel	10	Specifications	38
Cycle & Function Overview	11		
Wash + Dry Cycle	14		
Single Wash Cycle	15		
Single Dry Cycle	16		
OPTION Functions	17		
Care Function	18		
Lock Function	19		
Light Function	20		
Mute Function	21		
How To Use	22		
TOUCH ON	22		
Adding Detergent	23		

Safety Information

- The following precautions are for the safe and proper usage of this product. Be sure to follow them to prevent unexpected risks and damage.
- The safety-related precautions are classified according to the expected risk, the magnitude of damage, and the level of risk if used incorrectly.

WARNING

If these warnings are not observed, there is a possibility of serious injury or death.

CAUTION

If these cautions are not observed, there is a possibility of minor injury or product damage.

Installation Guidelines

WARNING

Be sure to use it alone with a grounded AC 220 - 240 V, 50 - 60 Hz rated outlet of 15 A or higher.

- If a transformer is used, it may result in electric shock or fire.
- If the voltage, frequency, or rated current are different, it may cause electric shock or fire.

Be sure to attach the back of the product to the wall for the installation.

When installing the product, install it at least 15 cm away from products that use fire or high heat, such as a gas stove.

- This may affect the product's exterior or performance.

Do not install or use the product in a place exposed to snow or storms, a place prone to have water pools, or where there is corrosive gas.

- There is a risk of electric shock, fire, breakdown, or deformation.

CAUTION

Do not use an extension cord without a ground wire.

- It may cause electric shock.

You must check the hose connection for leakage after installation.

- If the screws are loose, water leakage may result in electric shock or property damage.

Do not place other objects on top of the product.

- These objects may fall when you open the door.

Power Source Guidelines

WARNING

When you are removing the power plug, you must hold the plug and not operate or handle it with wet hands.

- Failure to do so may cause an electric shock or fire.

Connect the power plug firmly to the outlet, and do not use the outlet when it is loose.

- Failure to do so may cause an electric shock or fire.

Do not forcefully bend, twist, or pull the power wires. If the wires are damaged, please contact the Customer Service Center (1-800-18-7878) for an inspection.

- In case of leakage, it may cause a malfunction or electric shock.

Connect the power plug with the power cord facing down.

- If connected in reverse, the wire inside the power cord may be cut, causing a fire or electric shock.

Do not remove the plug while the product is operating.

- It may result in product failure, fire, or electric shock.

Do not place the dishwasher or heavy objects on the power cord or cover it with a cloth.

- Doing so may cause an electric shock or fire.

Use the product by itself with a dedicated outlet of 15 A or more.

- Failure to do so may cause an electric shock or fire.

Check if the power plug has dust on it, and fully insert it, making sure it is connected firmly.

- When it is covered with dust or the connection is unstable, it may cause a fire.

Usage Guidelines

WARNING

Do not use the dishwasher to wash objects other than dishes (electronic devices, such as mobile phones and cameras).

- It may damage the product.

Do not touch the water being drained.

- The water is hot and may cause burns.

Do not let children play with or operate the dishwasher. Keep children away from the dishwasher when the door is open.

- When the door closes, they might get stuck inside the dishwasher.
- The door may cause your hand to get caught in the dishwasher and cause injury.
- Parental supervision is needed to prevent children from playing with the product.

The product automatically opens the door with the automatic door opening function after the operation is finished. Do not place dishes or other objects in front of the dishwasher.

- It may result in falls and damage.

Keep the dishwasher detergent in a safe place out of the reach of children, and do not let children or pets ingest detergent or detergent water (residual water).

- If swallowed, there is a risk of mouth burns, vomiting, and difficulty in breathing.
- If swallowed, drink water or induce vomiting and seek medical advice from a doctor.

Place sharp kitchenware such as knives with the handles facing upward.

- Not doing so may cause injury.

Do not wash dishes with flammable substances, such as benzene, thinner, or gasoline, and do not store containers of flammable substances in the washing tank.

- Doing so may result in an explosion or a fire.

Do not put heavy objects on the door or push down on it while it is open. In particular, do not let children climb up the door.

- The product may overturn and cause injury.

Do not place it near heat sources, such as electric heaters, candles, or mosquito repellents.

- It may result in the deformation of plastic parts by heat, or melting of the cord, possibly causing a fire or electric shock.

If there is a gas leak, do not operate the dishwasher or power cord, and open the window to ventilate completely.

- If you try to operate the dishwasher or power cord under such circumstances, sparks may cause an explosion, fire, or burns.

Do not press the button with sharp objects.

- It may result in product failure or electric shock.

Keep body parts away from the part where steam is released, and do not open the door while the product is operating.

- Hot water might splash, or hot steam may result in burns.

Be careful not to get your fingers stuck while opening and closing the door.

- Not doing so may cause injury.

Do not put your hands inside the washing tank while the product is operating or right after the washing is complete.

- With the high-temperature drying feature, the dish rack may be hot.

When closing the dishwasher door, lightly push the top center to close it.

Do not abruptly open the door while operating.

- Hot water might splash, or hot steam may cause burns.

Be careful that pets or small animals do not damage the power cord and hose.

- The animals may be electrocuted, and it may result in product failure or property damage.

In an environment with many pests, insects, and bugs, pay attention to the environment where the product is placed.

CAUTION

Please use detergent that is recommended for residential dishwashers only.

- The use of general detergents may cause excess foaming, which may result in product failure, electric shock or fire.

Do not sprinkle water directly on the dishwasher as it has electric parts inside.

- It may result in a product failure or electric shock.

If the dishwasher is left unused for an extended period of time, close the middle valve and turn off the water supply.

- Otherwise, the water may leak and cause electric shock or property damage.

Do not use the dishwasher to wash dishes that are vulnerable to heat or that are too light.

- It may cause deformation or incomplete washing, and can ultimately cause product failure.

This dishwasher is intended for residential use only.

Product Breakdowns & Repairs

WARNING

Disassembly, repairs and modifications are permitted by authorized service technicians only.

- Otherwise, there is a risk of fire, electric shock, product failure, or personal injury.

Do not disassemble or modify the product when it is submerged in water or when it needs to be disassembled and reinstalled for moving, and use the product only after receiving service from a repair technician designated by the company.

- Failure to follow the above instructions may result in product failure, fire, or electric shock.
- Please contact the Customer Service Center. (1-800-18-7878)

If the product is generating smoke or an abnormal smell, stop using the product and disconnect it from the power and contact the Customer Service Center. (1-800-18-7878)

Before Using the Dishwasher

Before First Use

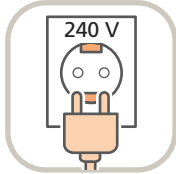

Connect the power plug to the power outlet.

- The product is intended for 240 V only.
- Connect to a 240 V outlet with a ground wire.

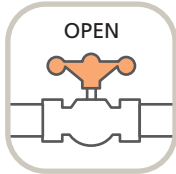

Open the valve of the water supply connection.

- Installable water pressure: 0.09 - 0.78 MPa



Remove food waste that may clog the filter in advance.

- If you do not remove the waste, the cleaning performance may deteriorate.

Preparing for Wash



STEP 1

Open the dishwasher door and put the dishes to be washed in the upper and lower racks.

- Discard large food waste elsewhere.

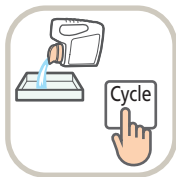

STEP 2

Pour an adequate amount of detergent into the detergent compartment, close the door, and choose the desired washing cycle.

- Recommended usage amount (Normal, Heavy, and Eco cycles): 7 g
- A liquid detergent may flow out and is not recommended.



STEP 3

When the washing is complete, open the dishwasher door and take out the clean dishes.

- Remove the filter and wash off any food waste with water.

Product Description

External Parts

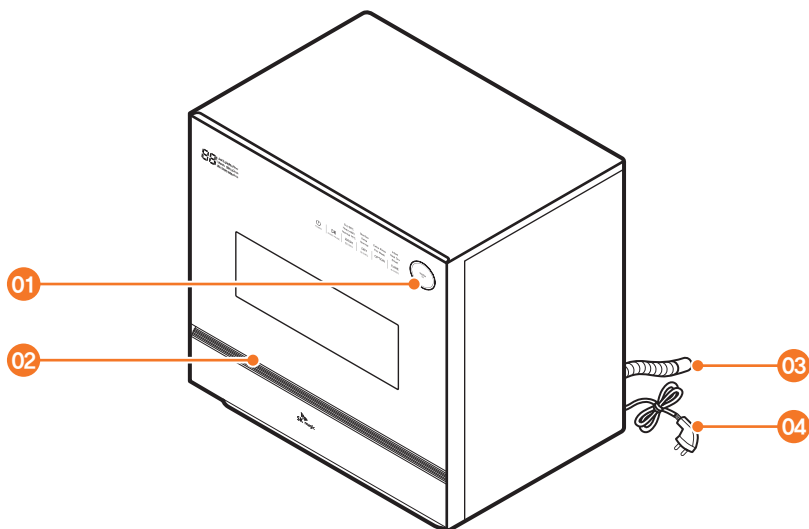

01 TOUCH ON button

02 Safety Light

03 Drain Hose

04 Power plug

Parts



User manual



Drain Hose



Drain Hose Fixer

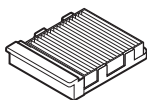

Air Care Filter*
(Fine Dust Filter)



Water Care Filter*
(Sediment Filter)

Accessories marked with * after the name are limited to their corresponding models.

Internal Parts

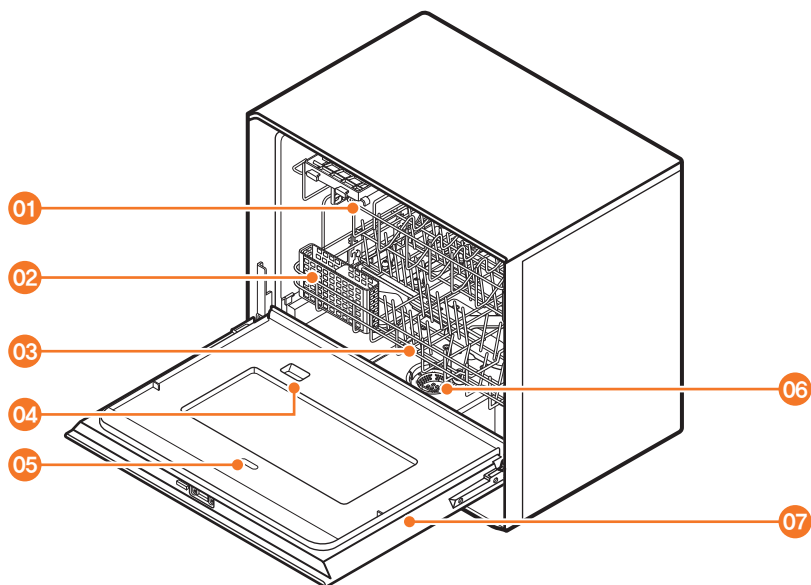

01 Upper rack

02 Cutlery rack

03 Lower rack

04 Detergent Compartment

05 UV LED

06 Dishwasher Filter

07 Dishwasher door

Separate Purchases



Dishwasher Detergent

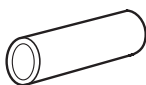

Water Supply Hose
Extension Pipe

NOTE

- Customers are responsible for the cost of additional parts required for installation.
- Contact the Customer Service Center (1-800-18-7878) to purchase additional parts.

Display & Control Panel

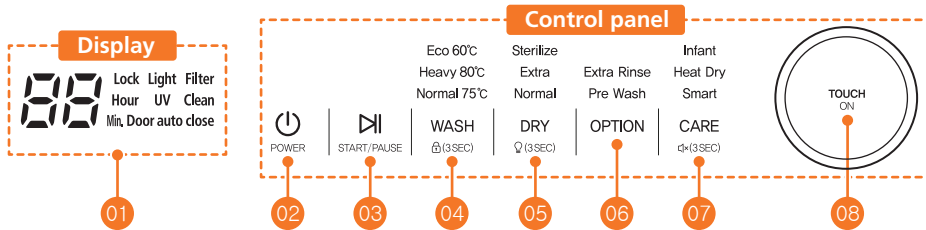

Classification	Button	Description
Display	01 Display	<ul style="list-style-type: none"> It displays the remaining time and operational status of the product.
Control panel	02 POWER	<ul style="list-style-type: none"> You can turn the power on or off.
	03 START/PAUSE	<ul style="list-style-type: none"> Select start or pause.
	04 WASH (Press 3 seconds to lock)	<ul style="list-style-type: none"> Select a washing cycle. If you press and hold the button for more than 3 seconds, the Lock function will be activated. If you want to deactivate the lock function, press the button again for more than 3 seconds. What is the lock function? It is a function that disables all buttons to prevent children from operating the product. (Including the TOUCH ON) button)
	05 DRY (Press 3 seconds for light)	<ul style="list-style-type: none"> Select a drying cycle. If you press and hold the button for more than 3 seconds, the Light function will be activated. If you want to deactivate the light function, press the button again for more than 3 seconds. When the light function is activated, the LED at the bottom will light up. If the LED is turned off, the function is deactivated.
	06 OPTION	<ul style="list-style-type: none"> Select an optional function. <ul style="list-style-type: none"> You can additionally select Pre Wash and Extra Rinse for the washing cycle.
	07 CARE (Press 3 seconds for mute)	<ul style="list-style-type: none"> It runs a cycle without washing or drying. If you press and hold the button for more than 3 seconds, the product is muted with OF(OFF) indicated. If you press and hold the button again for more than 3 seconds, the product is unmuted with On indicated.
	08 TOUCH ON	<ul style="list-style-type: none"> It is a touch button for opening the door. <ul style="list-style-type: none"> When the product is not operating, the door opens when the TOUCH ON button is touched for 1.5 seconds. When the product is operating, the door opens when the TOUCH ON button is touched for 3 seconds.

Cycle & Function Overview

- You must select the cycle before operation. The cycle cannot be changed during the operation.
- Changing the washing or drying cycle is not possible after the product starts operating. To change the cycle, you must turn the product off and then on again, choose the cycle that you wish to use, and restart the process. (The new washing and drying cycles will start from the beginning.)
- If you activate the care function, the door will automatically open for drying and automatically close after drying.
- If you deactivate the care function, the door automatically opens, and the product shuts down.

Wash + Dry Cycle

1. Cycle Description

Wash Cycle	Usage
Normal - 75°C	Standard program for light to normally soiled tableware.
Heavy - 80°C	High heat program for heavily soiled tableware.
Eco - 60°C	Low heat program for tableware with low heat resistance.

Dry Cycle	Usage
Normal	Standard program for ceramic tableware.
Extra	Strong program for plastic, silicon and steel tableware.

※ The Sterilize cycle does not include the washing function and cannot be used with the washing cycle.

OPTION	Usage
Pre Wash	Pre Wash cycle soaks up dried food before the Wash Cycle.
Extra Rinse	Additional rinse cycle after washing.

NOTE

- You can select and use the WASH, DRY, and OPTION cycles.
- First, choose the WASH cycle, then select the DRY cycle and OPTION functions.
- Please select appropriately according to how dirty the dishes are and the condition of the tableware.
- For individual washing, press the **[DRY]** button twice to select the Sterilize cycle, then select the washing cycle.

2. Program description

Wash Cycle	Washing	Rinse	Total operation time				
			Drying unselected	Normal drying	Extra drying	Pre Wash	Extra Rinse
Normal - 75°C	1 time	3 times	50 minutes	78 minutes	132 minutes	(If selected) +10 minutes	(If selected) +4 minutes
Heavy - 80°C	1 time	4 times	59 minutes	87 minutes	141 minutes		
Eco - 60°C	1 time	3 times	50 minutes	78 minutes	132 minutes		

NOTE

- When using washing and drying cycles, the door automatically opens and closes, and the UV LED turns on during the entire cycle.
- To only use the washing cycle, you can turn off the drying and care cycles.
- If you turn off the care function, the door opens, and the dishwasher shuts off after the washing and drying cycles.

Single Dry Cycle

1. Cycle Description

- The cycle is used to dry the dishes without washing them.
- Press the washing button 3 times to deactivate the washing cycle and just use the drying cycle.
- Hot air drying and the UV LED always operate during the single drying cycle.
- If you select the care function, the care cycle starts immediately after drying.
- If you turn off the care function, the door opens, and the dishwasher shuts off after the washing and drying cycles.

2. Program description

Cycle	Rinse	Operation time
Normal	-	60 minutes
Extra	-	120 minutes
Sterilize	1 time (77°C)	55 minutes (Rinsing: 27 minutes + Drying: 28 minutes)

※ The Sterilize cycle is a DRY cycle that does not need detergent. (Residual detergent may remain when detergent is added.)

Care Cycle

- The care cycle keeps the dishes clean after the washing and drying cycles by using the air care filter and UV LED for 30 minutes every 2 hours.
- You can select the care cycle in the washing + drying cycle, or in single drying.
 - You cannot select the care cycle in the single washing cycle.

1. Cycle Description

Cycle	Usage
Infant	<ul style="list-style-type: none"> • Recommended for silicone tableware or baby tableware • After drying the remaining water with hot air, operate the ventilation fan and UV LED to maintain hygiene
Heat Dry	<ul style="list-style-type: none"> • Recommended when you want to store general tableware more hygienically • The ventilation fan and UV LED operate on hot air to remove the remaining water and keep the dishes clean
Smart	<ul style="list-style-type: none"> • When storing general tableware, the ventilation fan and UV LED operate to maintain the dishes hygienically

※ Only some models are equipped with the air care filter (fine dust filter).

2. Program description

Cycle	Care		Operation time
	Ventilation fan	UV LED	
Infant	○	○	Operates for 48 hours <ul style="list-style-type: none"> • Hot air for 3 hours, waits for 2 hours twice → Repeats gentle air for 30 minutes, waits for 2 hours
Heat Dry	○	○	Operates for 48 hours <ul style="list-style-type: none"> • Hot air for 30 minutes
Smart	○	○	Operates for 48 hours <ul style="list-style-type: none"> • Repeats hot air for 30 minutes, waits for 2 hours, and gentle air for 30 minutes

※ All cycles end after a total of 48 hours of operation.

NOTE

- You can use various combinations of WASH, DRY, OPTION, and CARE cycles.
- Even if the power is turned off, the previously selected cycle is memorized and can be operated for later use.
- When you have to add dishes during washing, press the **[TOUCH ON]** button to open the door.
 - However, if you add dishes five minutes after washing begins, the performance may deteriorate.

Wash + Dry Cycle

This cycle simultaneously provides washing and drying.

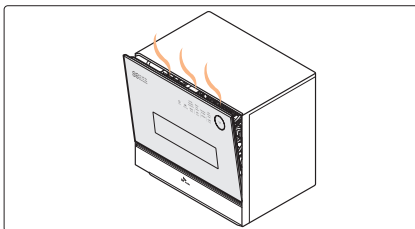
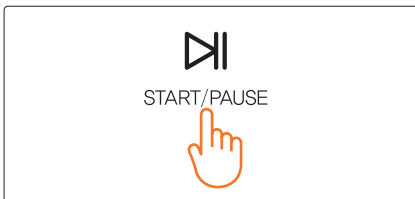
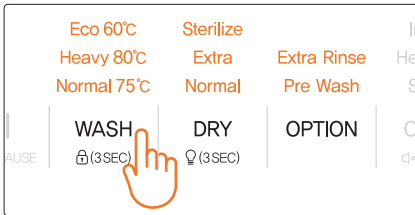
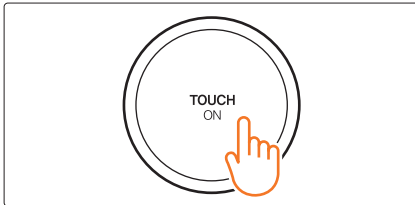

1. Press the **[TOUCH ON]** button to open the door and place the dishes to be cleaned in the dish racks.
2. Close the door.
3. Press the **[WASH]** button to select the cycle of your choice.
 - You can select a DRY cycle and an OPTION cycle along with the WASH cycle.
 - You can select between Normal and Extra DRY cycles.
 - Press the **[OPTION]** button to add the functions of your choice. You can choose Pre Wash or Extra Rinse, and both can also be selected simultaneously.
 - However, the OPTION functions are only selectable when you choose the WASH cycle.
4. Press the **[START/PAUSE]** button 1 time to start washing.
5. When washing is complete and the drying cycle starts, the dishwasher door partially opens to release steam.
6. When drying is complete, the alarm sounds, and the care function automatically starts. (If you have chosen the care function.)

CAUTION

- Do not abruptly open the door while the product is operating.
 - When the door opens during operation, be careful of the hot water splashing and hot steam, which can be dangerous.

Single Wash Cycle

This cycle only washes and does not dry.

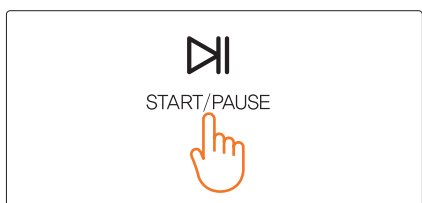
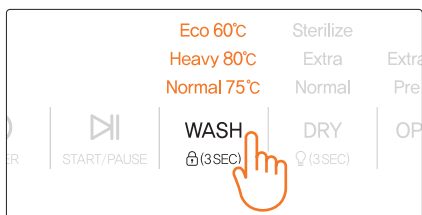
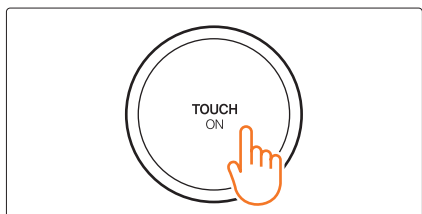

1. Press the [**TOUCH ON**] button to open the door and place the dishes to be cleaned in the dish racks.
2. Close the door.
3. Press the [**DRY**] button 3 times to deactivate the drying cycle.
4. Press the [**WASH**] button to select the cycle of your choice.
 - The drying cycle is deactivated, so the drying function and care function will not run.
 - Press the [**OPTION**] button to add the functions of your choice. You can choose Pre Wash or Extra Rinse, and both can also be selected simultaneously.
 - However, the OPTION functions are only selectable when you choose the WASH cycle.
5. Press the [**START/PAUSE**] button 1 time to start washing.
6. When washing is complete, the door opens automatically, the alarm sounds, and the dishwasher shuts down.

CAUTION

- Do not abruptly open the door while the product is operating.
 - When the door opens during operation, be careful of the hot water splashing and hot steam, which can be dangerous.

Single Dry Cycle

This cycle only dries and does not wash.

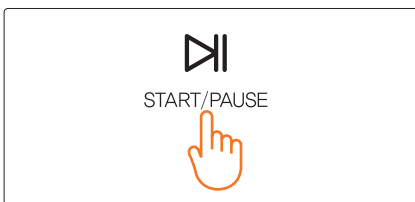
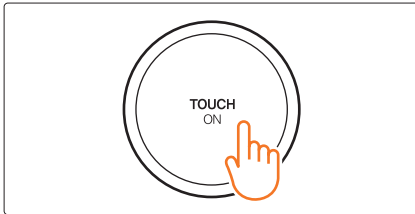

1. Press the **[TOUCH ON]** button to open the door and place the dishes to be cleaned in the dish racks.
2. Close the door.
3. Press the **[WASH]** button 3 times to deactivate the washing cycle.
4. Press the **[DRY]** button to select the cycle of your choice.
 - The washing cycle is deactivated, so the washing function will not run.
 - The Sterilize cycle is a function that dries dishes after rinsing them 1 time with hot water. You cannot add detergent as the washing function will not run.
5. Press the **[START/PAUSE]** button 1 time to start drying.
6. When drying is complete, the alarm sounds, and the care function automatically starts. (If you have chosen the care function.)

CAUTION

- Do not abruptly open the door while the product is operating.
 - When the door opens during operation, be careful of the hot water splashing and hot steam, which can be dangerous.

OPTION Functions

Use this when you add functions to the WASH cycle.

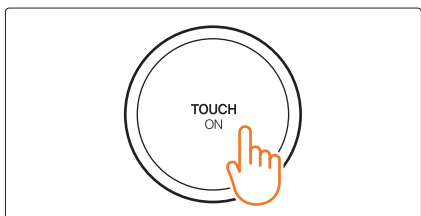

1. Press the [**TOUCH ON**] button to open the door and place the dishes to be cleaned in the dish racks.
2. Close the door.

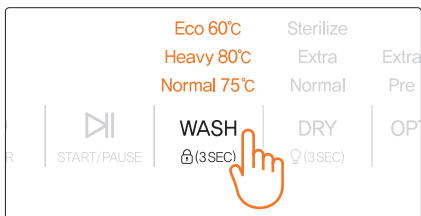

3. Press the [**WASH**] button to select the cycle of your choice.

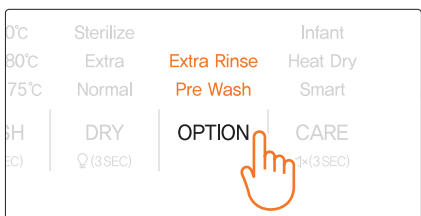

4. Press the [**OPTION**] button to select the function of your choice.
 - You can choose Pre Wash or Extra Rinse, and both can also be selected simultaneously.
 - However, the OPTION functions are only selectable when you choose the WASH cycle.
5. When washing is complete and the drying cycle starts, the dishwasher door partially opens to release steam.
6. When drying is complete, the alarm sounds, and the care function automatically starts. (If you have chosen the care function.)

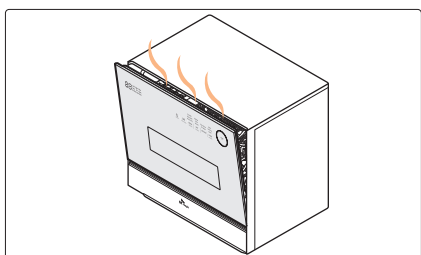

CAUTION

- Do not abruptly open the door while the product is operating.
 - When the door opens during operation, be careful of the hot water splashing and hot steam, which can be dangerous.

Care Function

Use this when managing dishes without the washing or drying cycles. In particular, you cannot dry the dishes only with the care function.

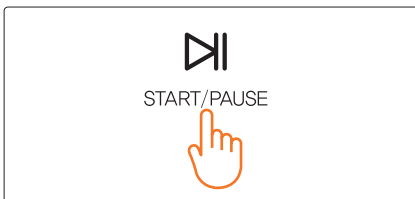
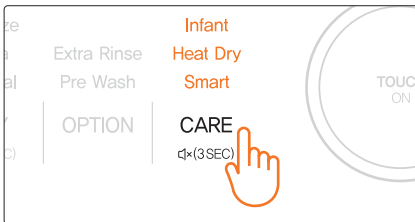
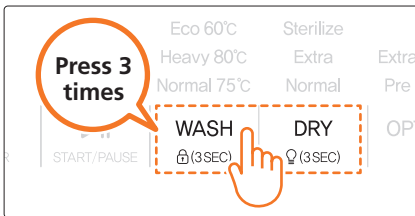
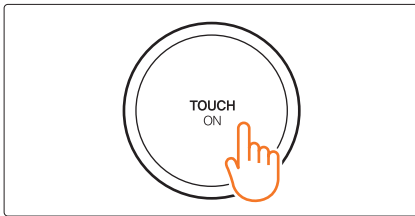

1. Press the **[TOUCH ON]** button to open the door and place the dishes to be cleaned in the dish racks.
2. Close the door.
3. Press the **[WASH]** button and the **[DRY]** button 3 times to deactivate the washing and drying cycles.
4. Press the **[CARE]** button to select the function of your choice.
 - **Infant**
When using silicon materials or baby tableware
 - **Heat Dry**
When storing general tableware more hygienically
 - **Smart**
When storing general tableware
5. Press the **[START/PAUSE]** button 1 time to start the care function.

CAUTION

- Do not abruptly open the door while the product is operating.
 - When the door opens during operation, be careful of the hot water splashing and hot steam, which can be dangerous.

Lock Function

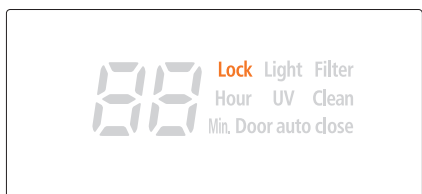

1. Press the [**WASH**] button for more than 3 seconds.
 - The lock status is shown as **Lock** on the display panel.
 - Press the [**WASH**] button for more than 3 seconds to deactivate the lock.
 - The lock function is deactivated with a 'ding' alarm sound.
2. The lock function is activated with a 'ding' alarm sound.

NOTE

- This function can be set while the product is operating.
- When the lock function is activated, the door does not open even when the [**TOUCH ON**] button is pressed.
 - You can only open the door using the [**TOUCH ON**] button after deactivating the lock function.
- Press the [**START/PAUSE**] button to activate the function only during operation.
- The lock function is deactivated when the cycle is complete.

Light Function

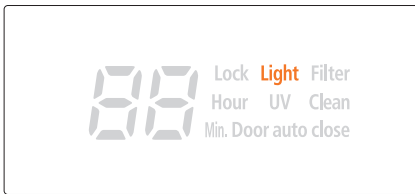
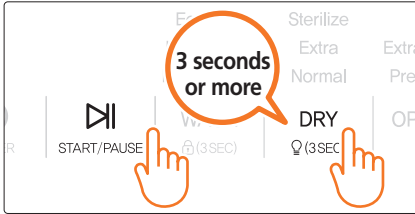

1. Press the **[START/PAUSE]** button 1 time and press the **[DRY]** button for more than 3 seconds.
 - When the light is off, **Light** is shown on the display panel.
 - Press the **[DRY]** button for more than 3 seconds to turn on the light, and **Light** on the display panel disappears.

NOTE

- This function can be set while the product is operating.
- When the dishwasher door is open while the power is on, the red LED lights up.
- When the door is not properly closed, the red LED lights up.
- When the washing cycle starts, the blue LED lights up.
- When the washing water temperature exceeds 60°C, the blue LED turns off, and the red LED blinks slowly.

Mute Function

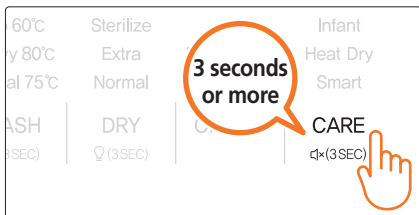

1. Press the [**CARE**] button for more than 3 seconds.

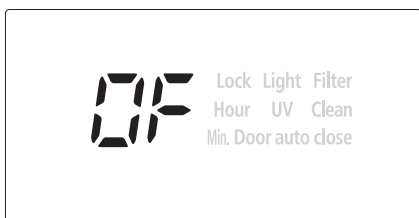

2. The mute function is activated with a 'ding' alarm sound.

- When activating the mute function, **OF** (OFF) is shown on the display panel.
- Press the [**CARE**] button for more than 3 seconds to deactivate the mute function.
 - The mute function is deactivated with a 'ding' sound, and **On** is shown on the display panel.

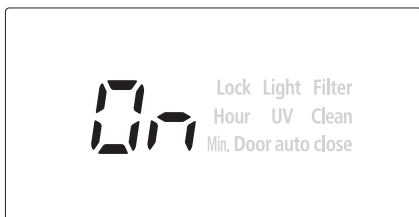

NOTE

- This function can be set while the product is operating.
- When the mute function is activated, buttons do not make a sound even when pressed.
 - Press the [**START/PAUSE**] button to activate the function only during operation.

How To Use

TOUCH ON

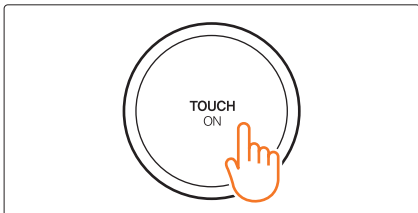

1. Press the **[TOUCH ON]** button on the front with your finger.
 - The door opens with an alarm sound.

CAUTION

- Do not open the door by force.
 - Open it by pressing the **[TOUCH ON]** button after connecting to the power plug.



2. When operated with the **[TOUCH ON]** button, the door opens completely.
 - When closing the door, lightly push the upper end of the door.
 - The door is completely closed when the **dr** sign disappears.

CAUTION

- Do not open the door by force as this may result in product failure.
 - Always open the door with the **[TOUCH ON]** button.



3. The door partially opens for drying. This does not mean that the door is completely opened.
 - When drying is complete, the door automatically closes.

CAUTION

- Do not open the door by force as this may result in product failure.
 - Press the **[TOUCH ON]** button to open the door completely.

Adding Detergent



1. Put an adequate amount of powder, tablet or liquid detergent into the compartment.



2. Close the door and press the **[START]** button.
 - If using tablet detergents, you can place them directly into the dishwasher.

NOTE

Classification		Cycle			
		Normal	Heavy	Eco	Sterilize
Detergent Type	Powder/ Liquid	7 g			No detergent
	Tablet	1/2 EA			

- Use only detergents recommended for dishwasher use.

Loading Dishes

Separating the Upper/Lower Racks

CAUTION

- The shape and material of the dish rack may be changed to improve dish storage.
- Do not pull out the upper and lower racks simultaneously when the dishes are stored.
- When you wish to wash larger dishes, remove the upper rack.

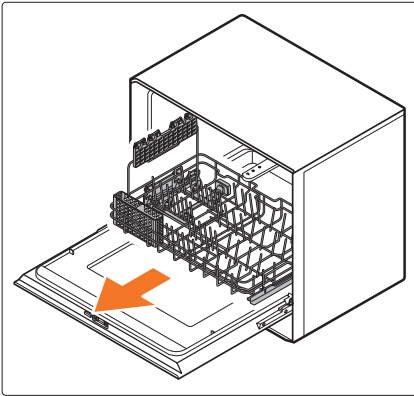

1. Gently pull the lower rack over the dishwasher door to remove it.

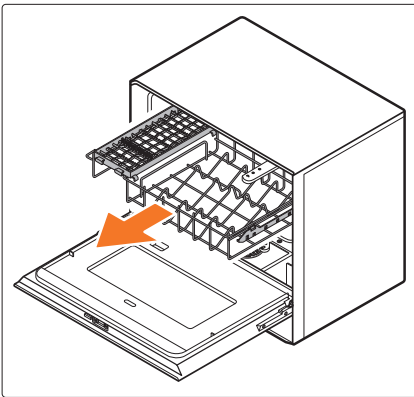

2. Slowly pull the upper rack forward until it stops.
 - When using tall dishes, remove the upper rack.
 - Pull the upper rack forward slightly, align it with the grooves on the left and right, and then lift it up to remove it.

NOTE

- If you pull out the upper rack first after completing the washing, the water from the upper rack might fall to the dishes in the lower rack, slowing down the drying.
 - Pull out the lower rack first, remove the dishes from it, and then proceed with the dishes on the upper rack.

Suggested Loading Pattern



Rack Loading Tips

CAUTION

- The shape and material of the dish rack may be changed to improve dish storage.
- Put light tableware, such as cups or melamine dishes, in the upper rack.

Upper Rack

- It is suitable to wash dishes of lower height, such as rice bowls, coffee cups, and frying pans.
- Place the side of dishes you wish to wash facing down.
- Place utensils, cutlery, forks, knives, tongs, etc., so that they do not overlap with each other.

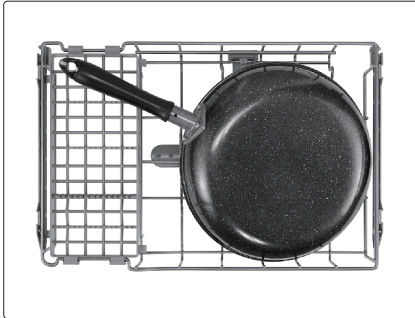
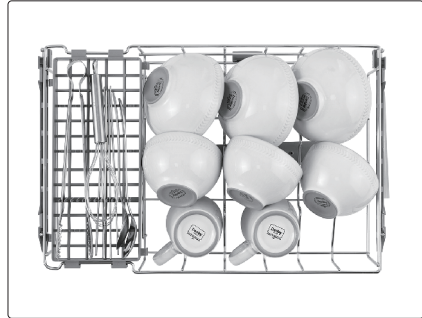
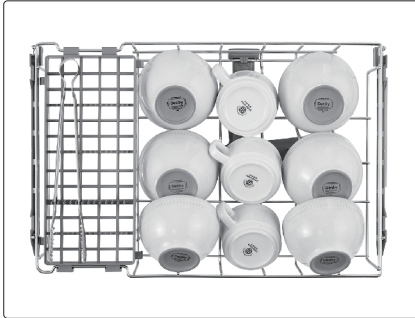

Lower Rack

- It is suitable for washing wide dishes, such as plates and pots.
- Place the side of dishes you wish to wash facing down.
- Place utensils, cutlery, forks, knives, tongs, etc., so that they do not overlap with each other.
- When washing large dishes, you can remove the upper rack.
- Be careful to keep dishes from going under the lower rack when putting them into the rack.
 - It may interfere with the rotation of the lower wash rotor and reduce cleaning performance.

NOTE

- The wine glass holder is limited to the corresponding model.

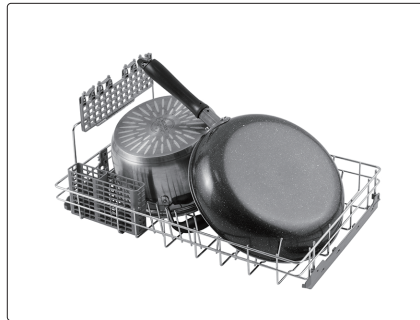
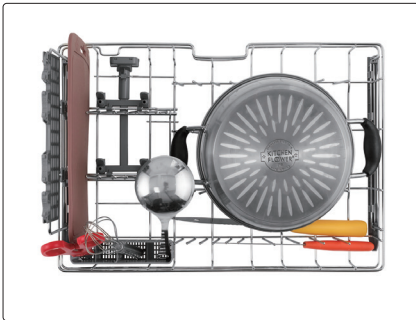
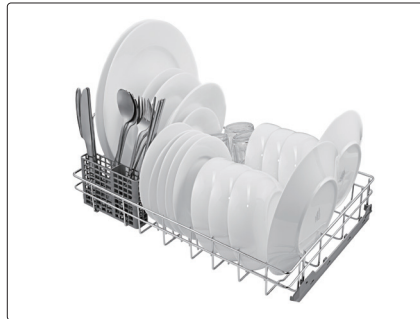

Wine Glasses (Applicable models only)

1. Put the wine glass holders down, as shown in the image.
2. Put the wine glasses into the holder and wash them.

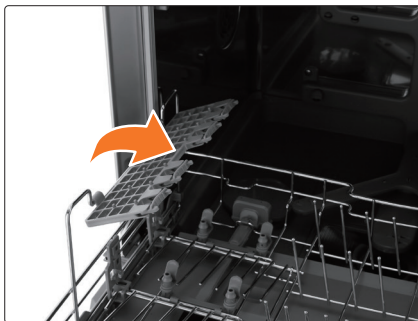

Intensive Flow zone

Put baby bottles, tumblers, and cups on the holders of the intensive flow zone to wash them.



Baby Basket

- Place baby bottle caps on the upper hanger, as shown in the image.
- Place the baby bottle holders and covers inside the box.
- Place them on the lower rack to wash them.



Maintenance

Cleaning the Filter

- After use, be sure to close the valve of the water supply connection and remove the power plug from the outlet for safety.
- Clean the product after the inside temperature has dropped sufficiently, about 30 minutes after the operation.

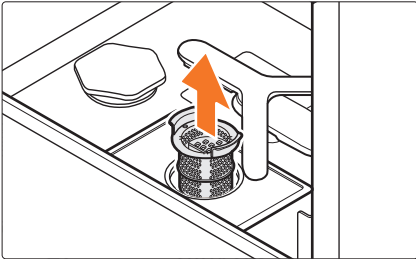

1. Pull the filter handle to lift it up and remove it.

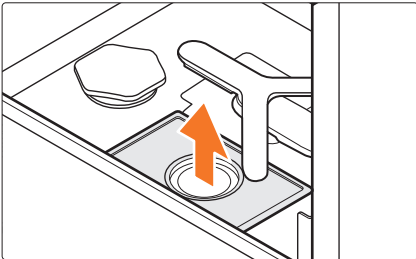

2. Pull out the fine filter.

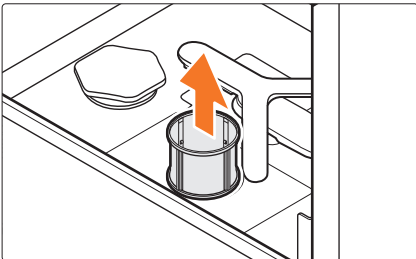

3. Pull the outer filter up and remove it.

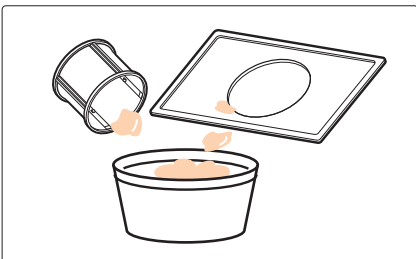

4. Remove food waste from the outer filter and fine filter.

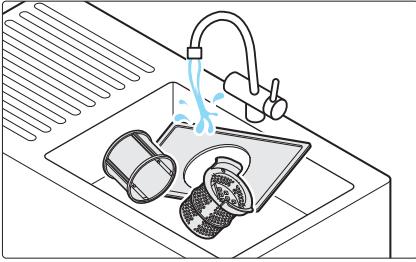

5. Wash the filter, outer filter, and fine filter with water.

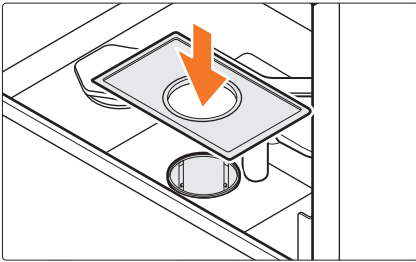

6. After reassembling the outer filter, precisely reassemble the fine filter under it.
 - If the filters are not properly assembled, washing performance may deteriorate.

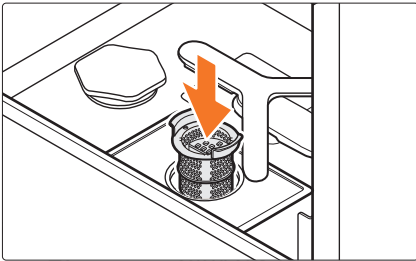

7. Push the filter down until it makes a **'click'** sound.

Cleaning the Dish Racks

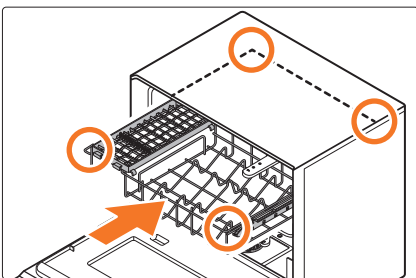

Pull the dish storage rack all the way out over the door with the door open. When installing, make sure to align the front and back.

CAUTION

- If you use the product without detergent for a long time, the dish rack may be discolored.

Cleaning the Inside and Outside of the Product

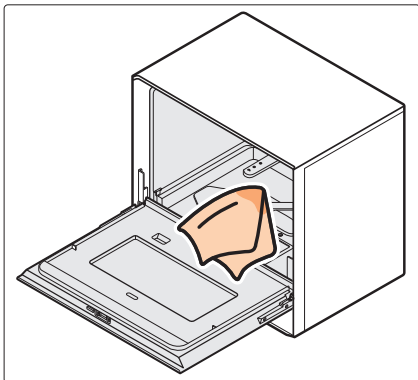

Clean the inside of the washing tank or the door with a damp cloth.

- Remove stains on the surface with a neutral detergent and wipe with a dry cloth.

CAUTION

- If you use bleach, benzene, or cleanser to clean the inside of the washer or the door, the product may be discolored or become rusty.

NOTE

- If you operate the dishwasher without loading it while using detergent, you can keep the product clean.

Managing Issues

When there are white spots, stains, discoloration, or odors.



When odor occurs

After removing the dishes, add 3 to 4 spoons (approx. 30cc) of vinegar and wash with the Sterilize cycle.

When there are stains or discoloration inside

After removing the dishes, add 1 spoon (approx. 10cc) of citric acid and wash with the Sterilize cycle.

- This problem may occur in regions where groundwater is used or that have high calcareous soil.
- The white stains are caused by the chemical reaction of ions with detergent ingredients in water containing high calcium, magnesium, and iron.

When the dishwasher is frozen



Pour in 5ℓ of water at a temperature of approximately 70°C and close the dishwasher door.

- Do not operate the dishwasher.



After 20 to 30 minutes, select the **Normal** washing cycle to check whether the product operates properly.

When there is a power or water outage



When there is a power outage

If the product stops operating during a power outage, try using it again once the power is back.



When there is a water outage

When there is a water outage during operation, press the **[POWER]** button to stop the operation and stop using the product.

When draining does not work



⚠ CAUTION

- Check for abnormalities in drainage paths.
- If the drain is clogged, do not use commercially available chemicals or detergents.
 - It may damage the product.
- When it is not possible to solve the issue, contact the Customer Service Center. (1-800-18-7878)

Replacing the Water Care Filter (Applicable models only)

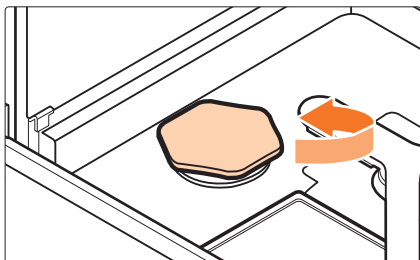

1. Remove the water care filter cover inside by turning it counterclockwise.

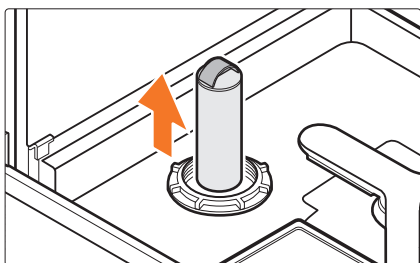

2. Grab the handle of the water care filter and pull it up to remove the filter.

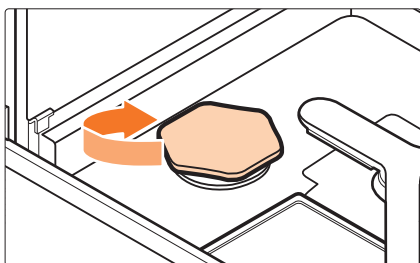

3. Install the new filter by inserting it from top to bottom, and close the cover.

Replacing the Air Care Filter (Applicable models only)

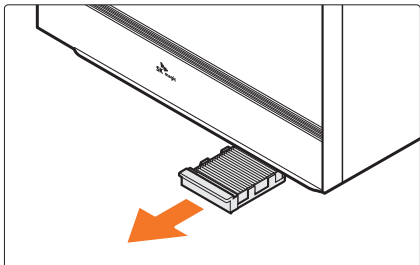

1. Remove the air care filter case at the bottom by pulling it forward.

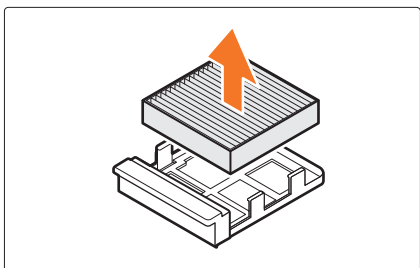

2. Remove the air care filter by pulling it up.

 **NOTE**

- Reuse the air care filter case by washing it with water.
- Before installing and using it, remove water on its surface.

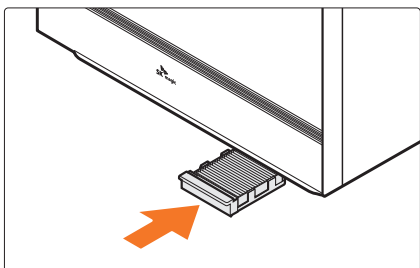

3. Install the new filter by inserting it from top to bottom, and close the cover.

Troubleshooting

If you encounter a problem with the appliance, first check the table below and try the suggested solutions. If the problem persists, please contact the Customer Service Center. (1-800-18-7878)

Problem	Checklist/Solution
The product will not start.	<ul style="list-style-type: none"> • Press the [POWER] button. • Check if the power plug is connected. • Check if there is a power failure or if the earth leakage breaker is not turned off.
It is not functioning at all.	<ul style="list-style-type: none"> • Press the [START/PAUSE] button. • Check if the power plug is connected. • Check if there is a power failure or if the earth leakage breaker is not turned off. • Check if the rated capacity of the power strip (or extension cord) is low. • Check if the door is completely closed. • Check if the safety lock is on.
It makes a strange noise during washing.	<ul style="list-style-type: none"> • Check if the dishes are placed against the washing spray blades. • Check if you put plastic dishes that are too light. • Check if the spray blades and the filters were properly cleaned and reassembled.
The dishes are not being washed properly.	<ul style="list-style-type: none"> • Place the dishes properly so that water can reach the inside of the dishes. • Check if the nozzle is blocked. <ul style="list-style-type: none"> - Clean the washing water nozzle. • Check if the dishes are overlapping with each other. <ul style="list-style-type: none"> - Store the dishes properly. • Check if general detergent was used. <ul style="list-style-type: none"> - Use special detergent for the dishwashers.
White stains and discoloration occur on dishes and inside of the product.	<ul style="list-style-type: none"> • Underground water may cause stains or discolorations. <ul style="list-style-type: none"> - This may also happen with some water supplies. • The white stains or discoloration may occur when washing at high temperatures with water containing a lot of calcium, magnesium, or iron. • If you see white stains or discoloration, follow the steps below. <ul style="list-style-type: none"> - Select and run the Normal cycle. - After 3 to 5 minutes of operation (when cleaning), press the [START/PAUSE] button or the [TOUCH ON] button to pause. - Open the door and put 3 to 4 spoons of vinegar inside the dishwasher. (approx. 30cc) - Close the door and press the [START/PAUSE] button to continue the operation.
Stainless dishes are discolored to a yellow hue or slightly black hue.	<ul style="list-style-type: none"> • This is because of the iron contained in water. To prevent this, pour vinegar (approx. 30cc) into the washing tank and operate the product about once a month.
There is no water supply.	<ul style="list-style-type: none"> • Check if the water supply hose is connected. • Check if the intermediate valve is properly opened. • Check if there is a water outage (no water supply).

Information Codes

The Control Panel displays information codes to help you understand what is occurring with your dishwasher. If the same situation continues, contact the Customer Service Center. (1-800-18-7878)

Code	Action
E2	<ul style="list-style-type: none">• There is an issue with the water supply.<ul style="list-style-type: none">- Check if the intermediate valve is open.- Check if the water supply has stopped.- Check if the water pressure is too low.- Check if the water supply hose is bent or pressed.
E3	<ul style="list-style-type: none">• There is an issue with drainage.<ul style="list-style-type: none">- Check for abnormalities in drainage paths.- Check if the drain hose or drainage hose is blocked.- Check if the drain hose is bent or pressed.
F1~F9	<ul style="list-style-type: none">• There is an issue with a function.<ul style="list-style-type: none">- Turn off the power and disconnect the product from the power. Close the intermediate valve and contact the Customer Service Center. (1-800-18-7878)- The F1 error code may be displayed if the filter is not cleaned or the water supply valve is closed.- If special detergent is not used, the F5 error code may be displayed due to excessive bubbles. Continue using the product after removing the foam.
E5, E0	<ul style="list-style-type: none">• There is an issue with temperature detection.<ul style="list-style-type: none">- Turn off the power and disconnect the product from the power. Close the intermediate valve and contact the Customer Service Center. (1-800-18-7878)

Specifications

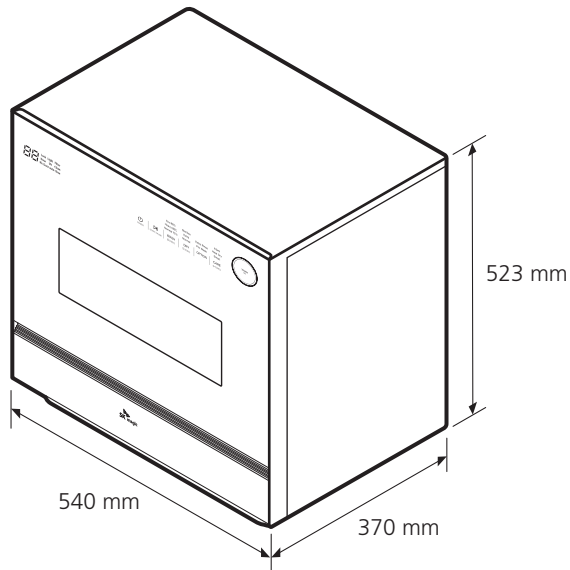

Product Name	Triple Care Dishwasher
Model	DWA19R0P, DWA19C0P
Max. Power Consumption	1,830 W
Rated Voltage	(220-240) V~, 50/60 Hz
Water consumption	8.7 L
Operating Pressure & Temperature	0.09 - 0.78 MPa, below 60°C
Dimensions (mm)	540 (W) × 370 (D) × 523 (H)
Weight	21 kg

The product appearance and specifications are subject to change for quality improvement without prior notice.

Memo

